



KS

Our Intent

‘Powering the Dismounted Operator, reducing complexity, cost and cognitive load whilst adding genuine best in class capability and value’.



MAAK ECOSYSTEM BUILT TO ADAPT TO THE MISSION



DISMOUNTED

Solutions engineered for personnel operating on foot, prioritizing modularity, rapid reconfiguration, and secure device integration. Systems are designed to maintain operational capability in dynamic environments while minimizing weight and profile.



MOUNTED

Vehicle-mounted solutions for secure equipment integration, environmental resilience, and rapid reconfiguration. Built to maintain power and data under vibration, shock, and extreme conditions, while enabling quick transitions between vehicle and operator setups.



MISSION PLANNING

Pre-deployment systems and tools for configuring, synchronizing, and preparing mission equipment at scale. Focused on streamlining operational readiness, ensuring all devices, networks, and power assets are configured to mission parameters before deployment.

IT ALL STARTS WITH THE CASE

THE CASE IS THE CORE OF THE ECOSYSTEM. EVERYTHING CONNECTS, MOUNTS, AND SCALES FROM IT.



FORGE PHONE CASE
RUGGED, UTILITARIAN, YET SLIM

Front Loading Design

Case designed for front phone loading with thickness changes to localize top flex area.



Unibody Structure

Unibody design adds targeted flexibility while keeping mounts rigid, reducing parts.



Removable Dust Cover

A removable dust cover eliminates any debris and water from entering the ports.



Dual-Position Mounting

Simultaneously access accessories on the phone while mounting the case on your carry mount.



Phone Cable Lock

Positively locking, IP67 rated data and power tether to prevent inadvertent separation.



Screen Protector Compatible

All Forge Cases are compatible with many OTS screen protectors.



EUD CASES

CURRENT OFFERING



Samsung S20FE

- Coyote Tan
- OD Green
- Graphite Black



Samsung S23/S23TE

- Coyote Tan
- OD Green
- Graphite Black



Samsung S24/S25

- Coyote Tan
- OD Green
- Graphite Black



Samsung S25 Ultra

- Coyote Tan
- OD Green
- Graphite Black



Samsung XCover7 Pro

- Coyote Tan
- OD Green
- Graphite Black



Google Pixel 9

- Coyote Tan
- OD Green
- Graphite Black



Samsung Tab 5 Active / TE

- Coyote Tan
- Graphite Black

From Sketch to Production in 5 Months

With over 15 years in the phone case industry, the Bunker team has developed a system enabling mass production in 5 months. This opens collaboration opportunities for teams looking to integrate an EUD model not currently in the production line.

CABLES



FORGE CABLE LOCK EUD USB-C to ODU 12 PIN AMC CONNECTOR

UNIVERSAL

The opening of the Cable Lock can be adjusted for different EUD case thicknesses.



COMPATIBLE

With Partner cables for extending the range of cable attachment to the EUD.



SECURE

Removable layer to attach the Lock to the cable or the Lock to the EUD.



EUD USB-C to USB-C



EUD USB-C to POWER MODULE USB-C



POWER MODULE USB-C to USB-C



POWER MODULE DAISY CHAIN



THE MAAK ECOSYSTEM

THE ECOSYSTEM ENTAILS VARIOUS **FORGE PHONE CASES, MOUNTS, LOCKING CABLES** WITH A WIDE VARIETY OF COMPATIBILITY, AS WELL AS OUR UNIQUE FEATURE:

FIELD MODULE SYSTEM

THAT CAPABILITY IS WHAT SETS US APART:

A EUD Cases

B. Mounts

C. Cables

D. Field Modules

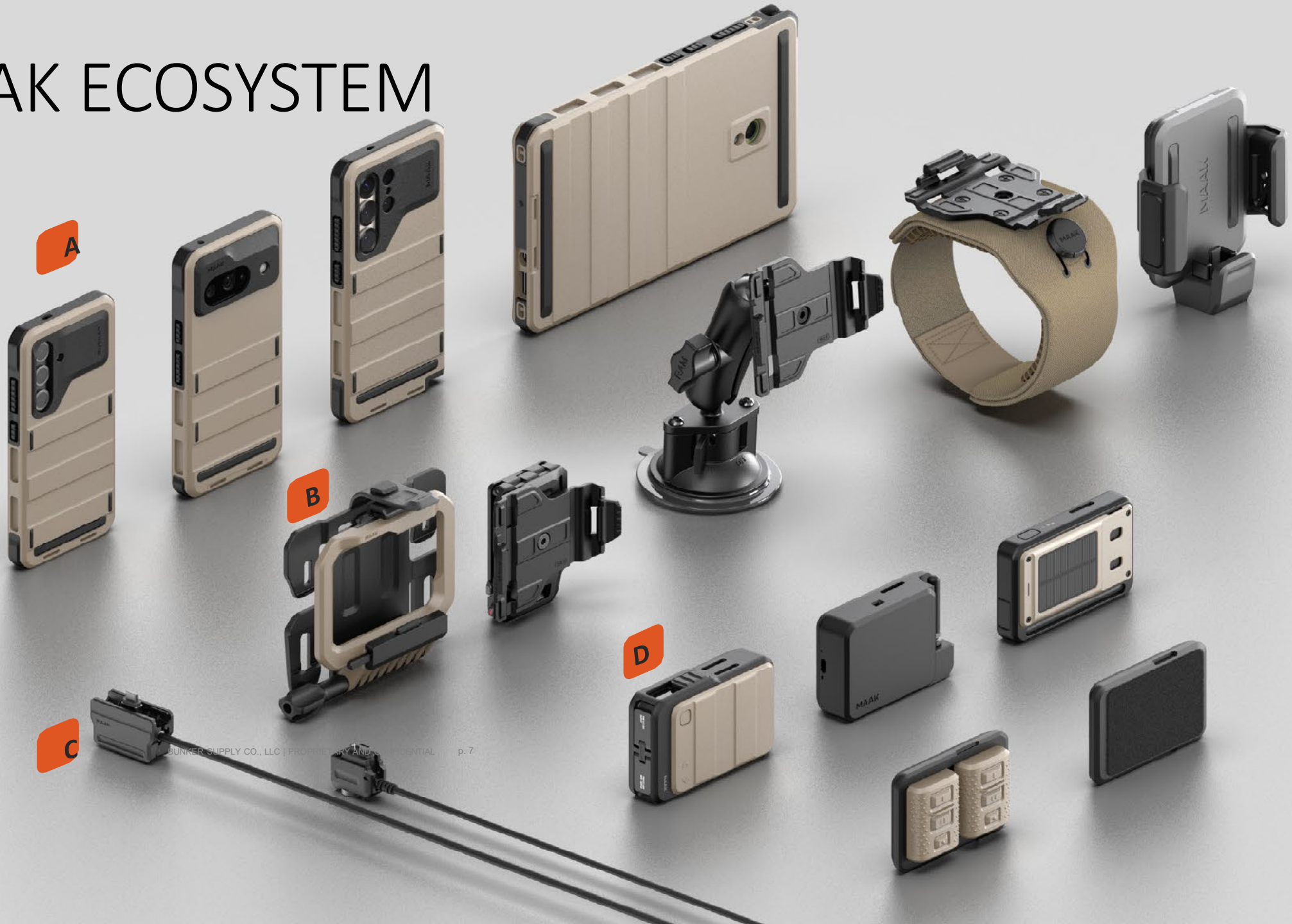

FIELD MODULES

DESIGNED TO ADAPT

The Field Module system transforms your chest rig into a mission-configurable platform

- scalable, modular, and built to evolve with user requirements.

FIELD MODULES QUICK RELEASE SYSTEM

- Integrated front mount
- Single-handed operation
- Rapid release & reconfiguration
- Secure Module interface

Scout Battery Power Module

Step 1



Step 2

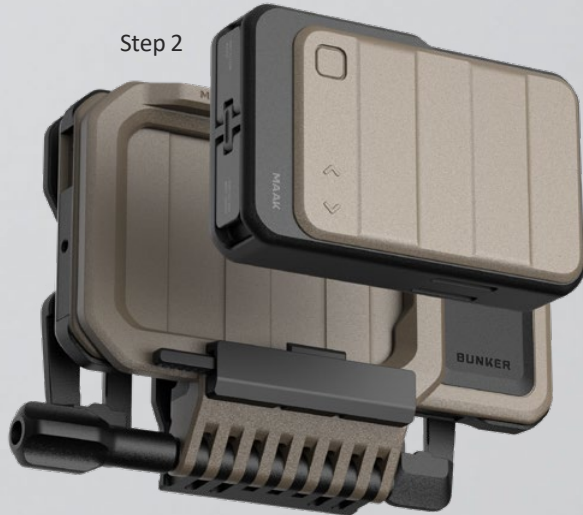

Easy to Insert or changeout for rapid mission needs

p. 8

NAVboard Module



Admin Pouch Module



PTT Module

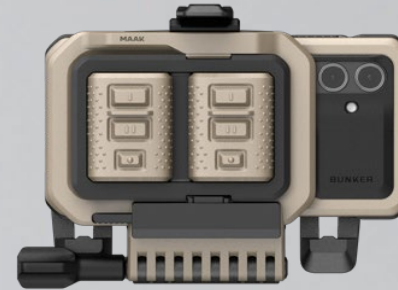

Universal Mount Module



LoRa Communication Module



Bespoke Comms module



FIELD MODULES

THE FLAGSHIP FIELD MODULE:
SCOUT BATTERY
NOW LAUNCHING INTERNATIONALLY

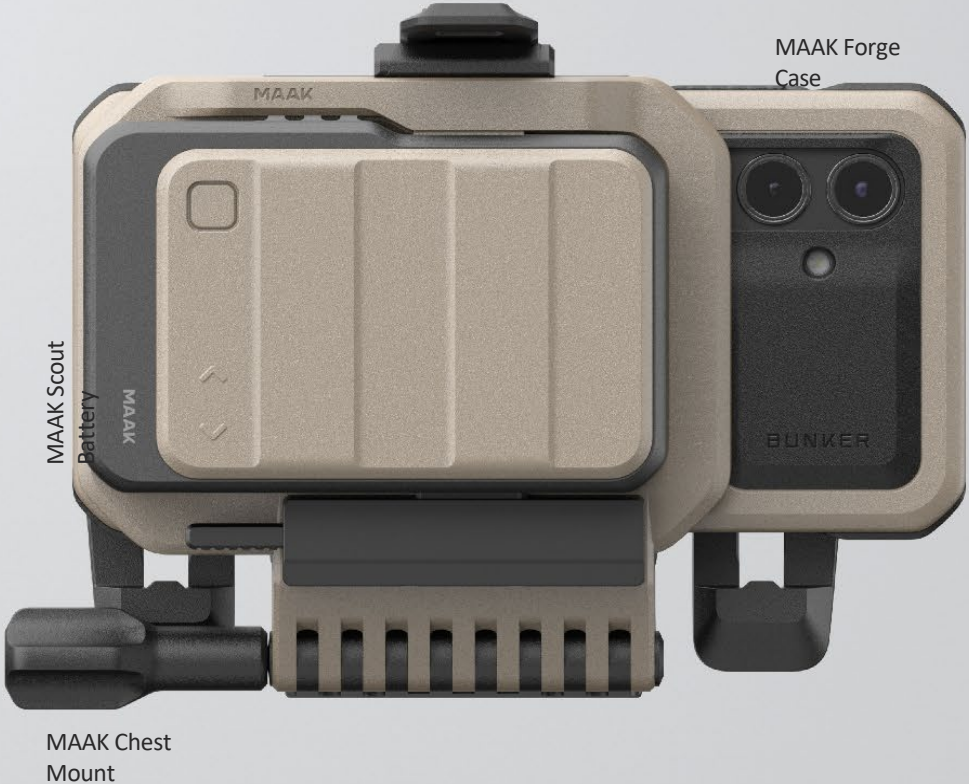

SCOUT BATTERY
RUGGED POWER
MODULE

Modular Power Solution Adaptable to Every Mission

The Scout Battery features 10,000mAh lithium-ion cells, 75W output, and IP67 rating for reliable performance in harsh conditions.

Smart Capabilities

- Real-time Power
- Metrics Hibernation Mode
- Stealth Mode

Faster Charging

- 45W PD USB-C + 15W USB-C
- 15W Wireless Charging
- Fast Recharge 80% in 45 minutes.



Rugged & Waterproof

- MIL-STD 810 & Beyond
- Waterproof Cable Locking
- Min -20°C Max 50°C



Compatible Mounts

The MAAK ecosystem offers a full suite of Interchangeable mounts for all Mission Modules



LIGHTWEIGHT ARCHITECTURE

WIRELESS POWER

A NEW LIGHTWEIGHT ARCHITECTURE



Wireless Charging Coil

With up to 15W of wireless charging power, Scout utilizes the fastest available wireless charging tech and is MagSafe compatible with iPhones.

MAAK Lightweight System



-MAAK Forge Case

-MAAK Chest Mount

-MAAK Scout Battery

1x MAAK Forge Tactical Cable –
Radio (Agnostic)

MODULAR ARCHITECTURE

PART OF THE **LIGHTWEIGHT ARCHITECTURE** MEANS ADAPTING TO VARIOUS MISSIONS

HERE IS WHAT WE DO WITH **COLD MISSIONS**



FORGE LT KIT
The Forge LT Kit includes a heating pad and power connector, designed to fit the standard MAAK Forge phone case. The heating pad installs inside the case and connects to the power source.

55 °C

MAX HEAT CAPACITY

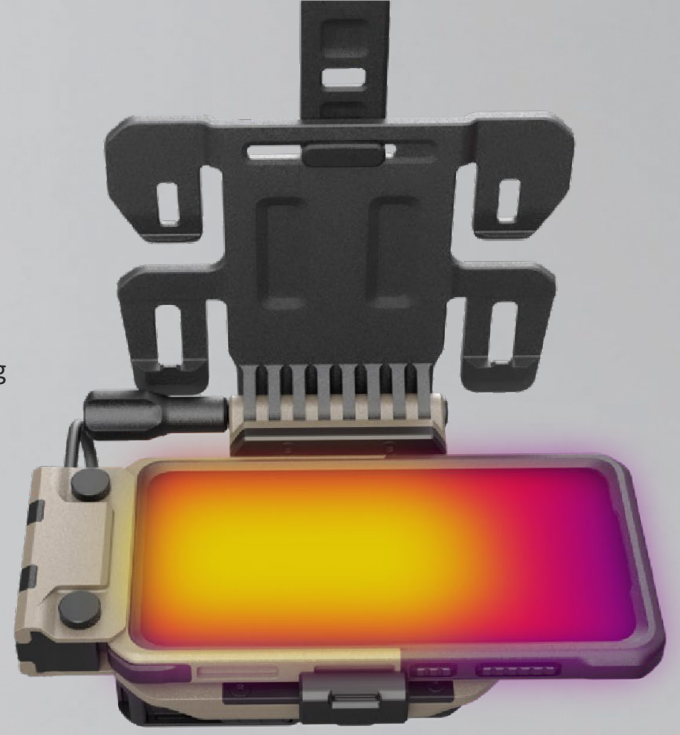

Compatible with current and future MAAK Forge Phone Cases

MODULAR
Operator can connect to a chest-mounted Scout battery while staying connected to the radio's data thanks to dual cabling

WATERPROOF
The Forge LT EUD Connector locking mechanism, in conjunction with the Scout Locking Cable, ensures an end-to-end IP67 connection.



FORGE LOW TEMPERATURE KIT ENHANCE EUD PERFORMANCE IN COLD WEATHER

VEHICLE MOUNTS

FROM DISMOUNTED
TO MOUNTED CLOSE
COMBAT.
ONE ECOSYSTEM.
ZERO FRICTION.



© 2022 BUNKER SUPPLY CO., LLC | PROPRIETARY AND CONFIDENTIAL p. 12

MAAK DEX STATION
FROM EUD TO
WORKSTATION

URNS YOUR PHONE INTO A WORKSTATION



CAC/PIV INTEGRATION WITH SAMSUNG



WHAT ELSE IS BUNKER'S INNOVATION PORTFOLIO?

The Bunker team is constantly developing new products and solutions in partnership with the U.S. Air Force, U.S. Navy, and U.S. Army. From human systems to edge computing, we design and deploy mission-ready solutions.

ACCLIMATE

- DECREASE TEMPERATURE BY 32°F (18°C)
- UP TO 12 HOURS OF COOLING



FITS ALL PLATFORMS



BACKPAC K



PLATE CARRIER

BUNKER SUPPLY CO., LLC | PROPRIETARY AND CONFIDENTIAL p. 14

NACEAR



SABR



MAAK IS EVOLVING. WHAT'S NEXT FOR THE MAAK ECOSYSTEM?

With a focus on power and communications, MAAK is actively developing the next generation of mission-ready products - expanding the ecosystem across sensors, controllers, lighting, communications, and cables.

SENSOR INTEGRATION

COMMUNICATION SUITE

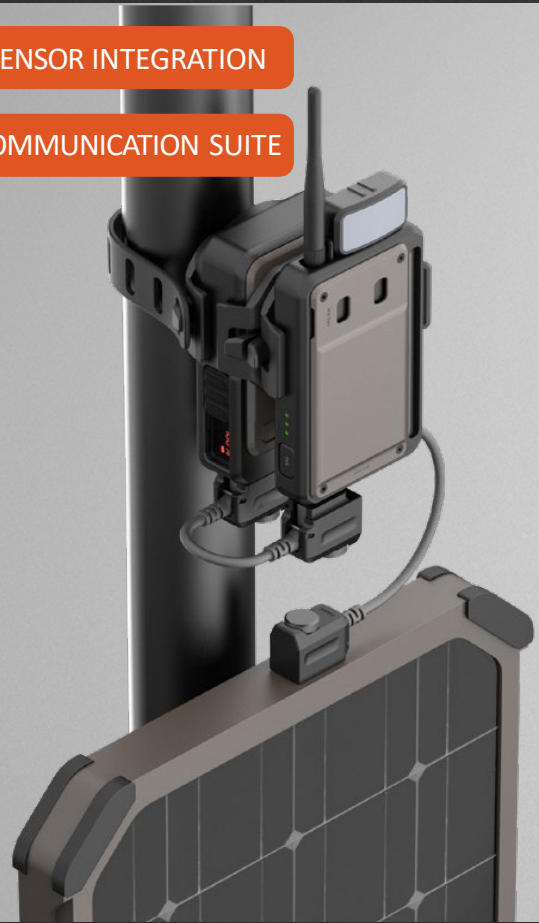

FUTURE PRODUCTS



BUNKER SUPPLY CO., LLC | PROPRIETARY AND CONFIDENTIAL | 15

SUCCESS IS BUILT ON COLLABORATION

PARTNERSHIP & COLLABORATION



Integrate your product into our platform.

OPEN SOURCE PROGRAM



Open platform to customize and build.